

Programmed Water Technologies

Sloan's Programmed Water Technologies solution is a water management system developed for harsh environments such as prisons, behavioral health institutions, and public showers and gyms. It is designed to minimize vandalism risks.

The system consists of several networkable products which may be connected together to offer different levels of security, control, and scalability. They are designed to be independent of other systems to easily integrate and configure into both new and existing projects. The components include flushometers (flush valves), controllers, manifolds, buttons, showerheads, and a PC-based software management system.

Why PWT

PWT manages water usage through controlling the number of flushes and the length of faucet and shower activations. The purpose of this control is to set new rules for user behavior.



Reduces water usage

Achieve water savings through fewer toilet flushes and timed faucet flow and showers.



Reduces vandalism cost

System minimizes toilet overflows and lessens maintenance time, parts costs, and linen and clothing replacement.



Reduces water costs

Visualize and control water throughout your facility to lower water and sewer bills.



Reduces risk

All PWT products are designed to minimize vandalism and tampering.



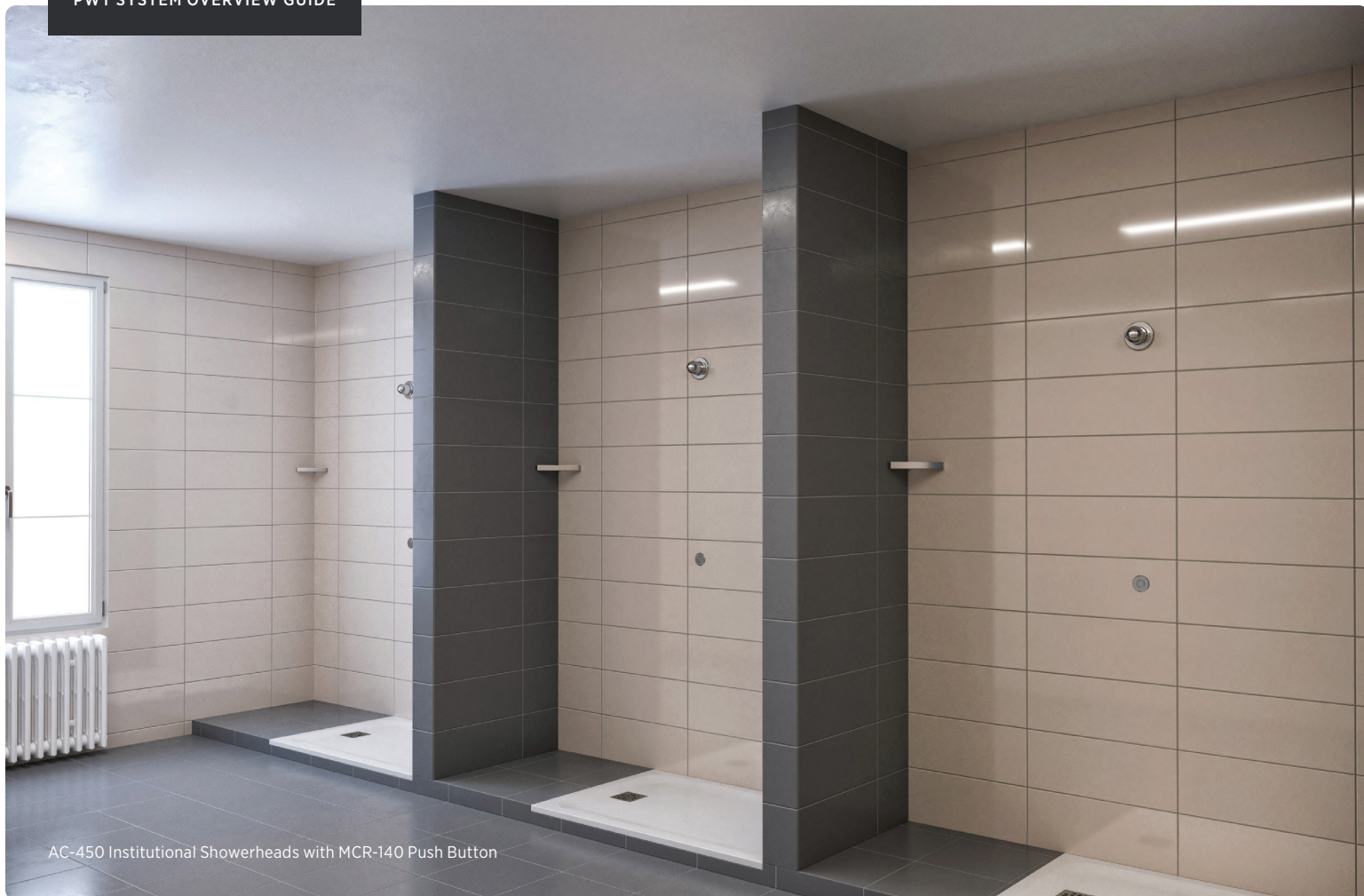

AC-450 Institutional Showerheads with MCR-140 Push Button

System Types

PWT system components can be configured in various ways for different applications. Some of the more popular use cases include toilet control, shower control, and full restroom or cell control. In projects where water usage must be monitored, Sloan's PWT Management Console system provides remote monitoring, control, and alerts for the networked products.

Full prison cell or complete restroom system

PWT may be used to manage the water usage in controlled systems:

Back-of-wall components

- Thermostatic mixing valve
- PWT flushometer
- Shower solenoid
- 4-I/O twisted pair communicating controller
- 2-line mixing manifold
- 24V transformer

Front-of-wall components

- Act-O-Matic® institutional showerhead
- Button for shower control
- Push buttons for hot/cold water for lav
- Push button assembly for toilet

Back-of-wall system type configuration

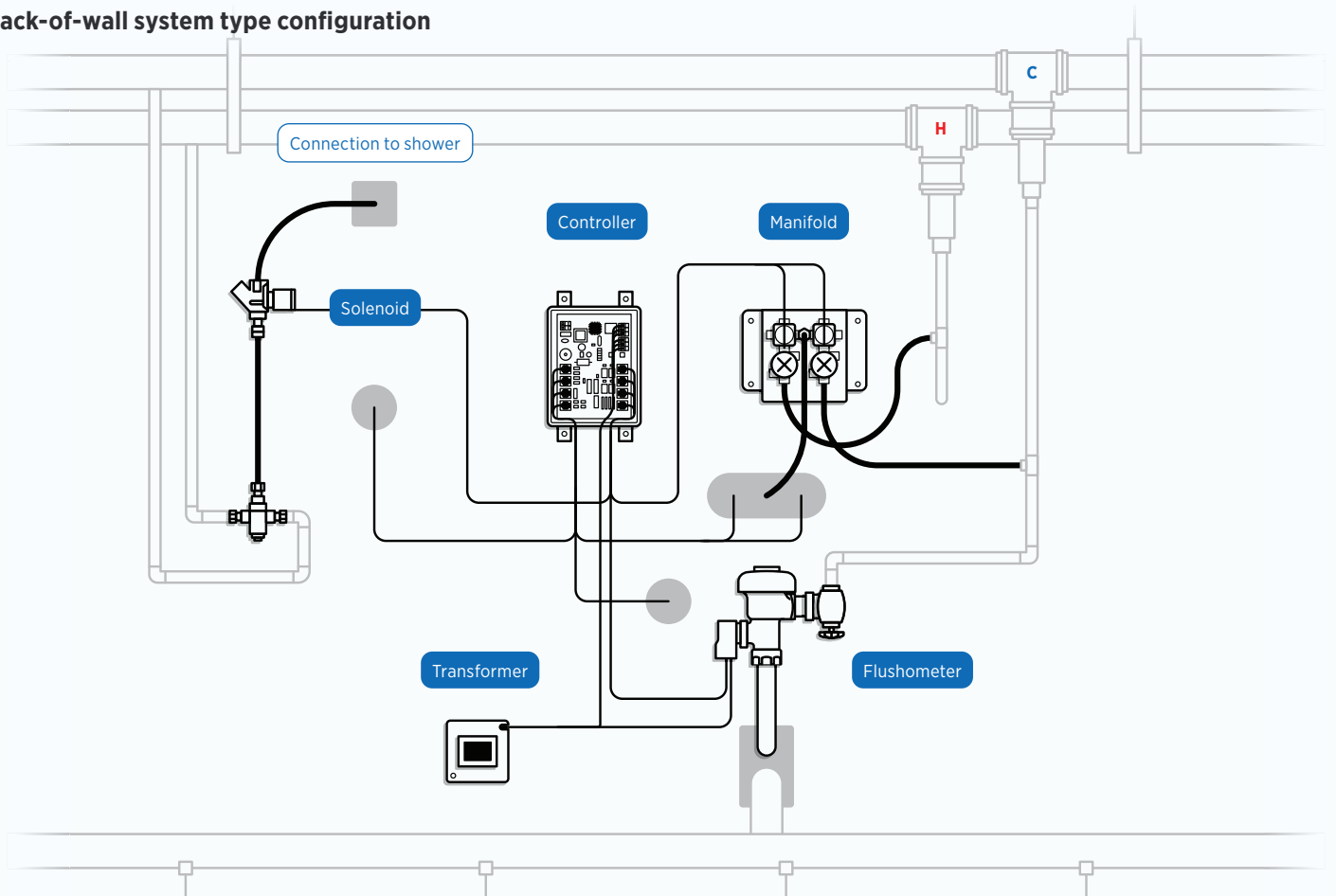

Front-of-wall system type configuration

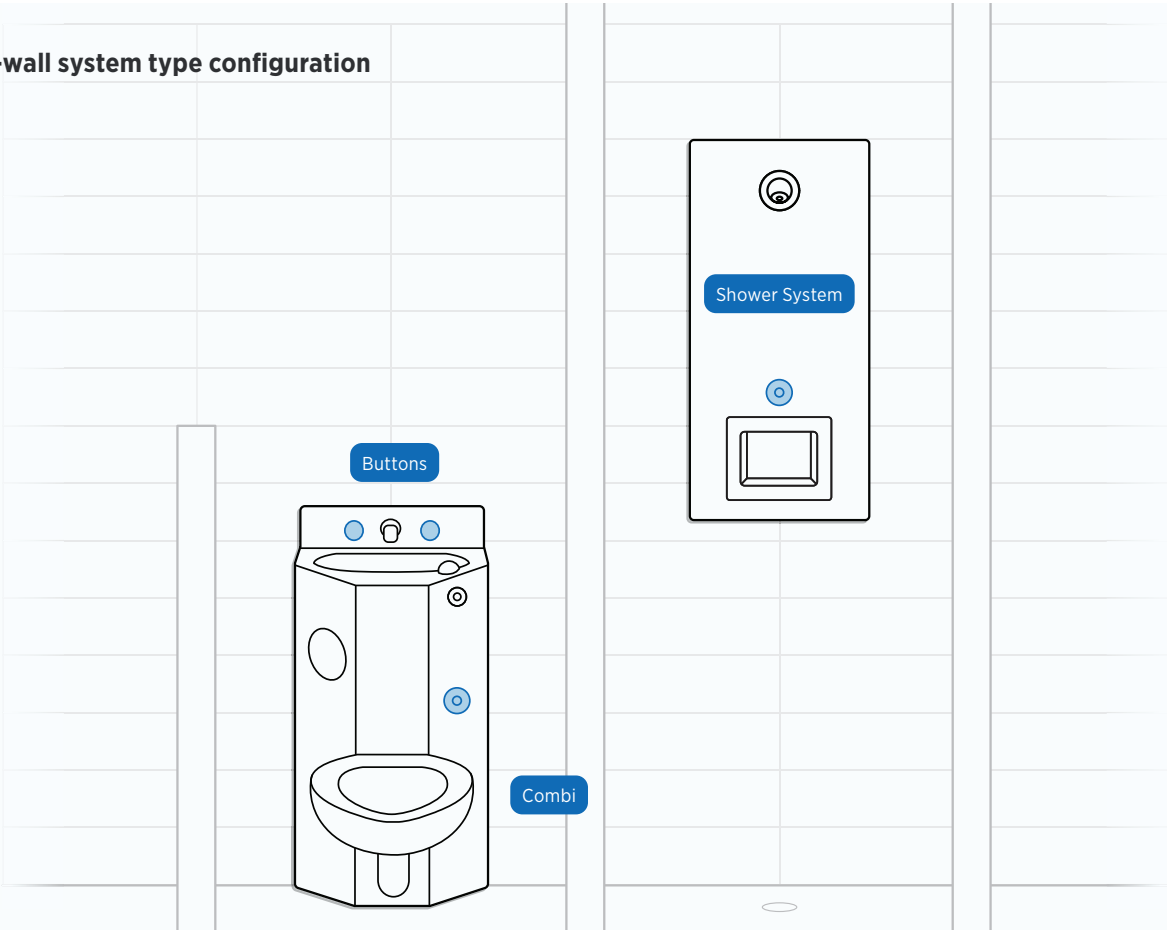

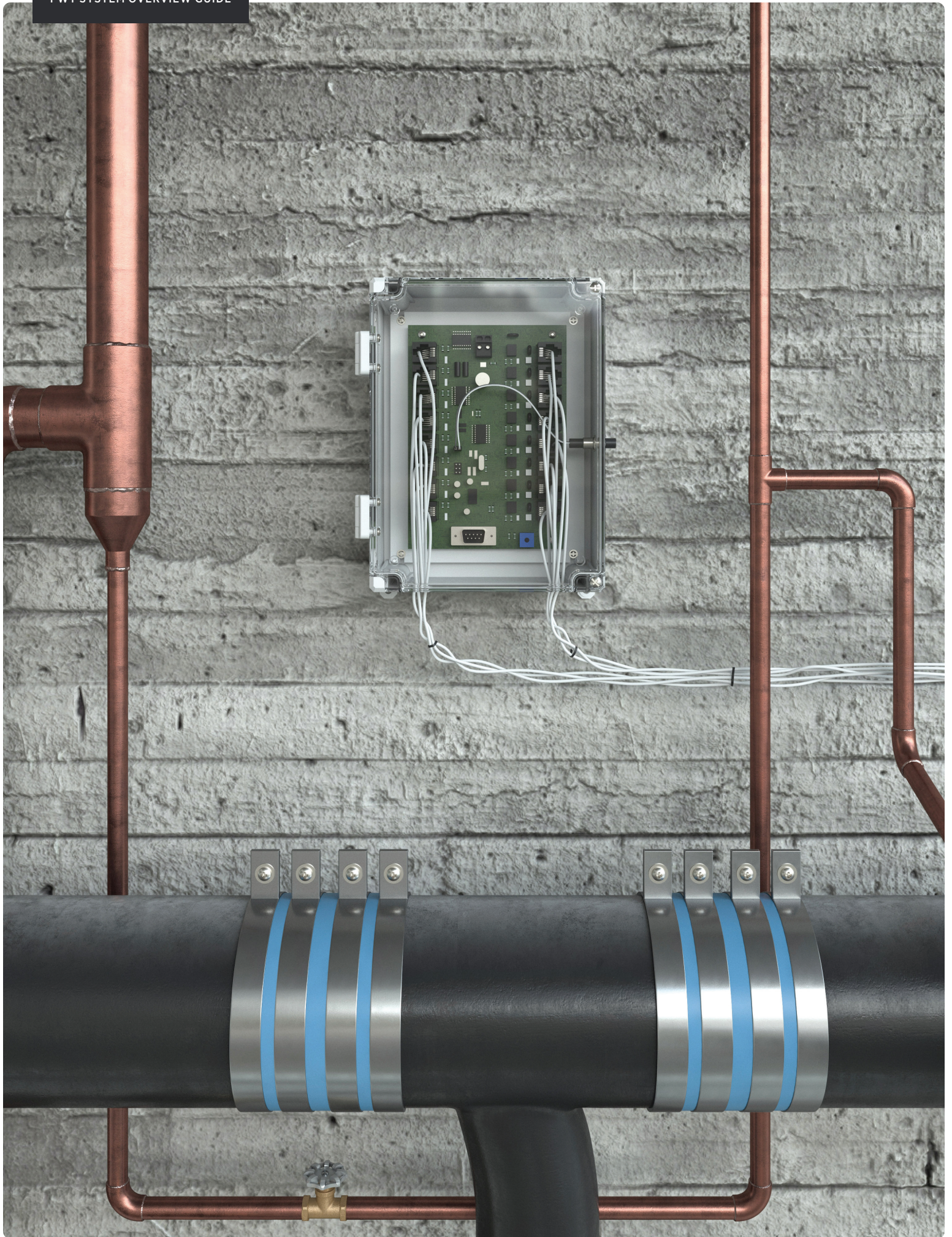

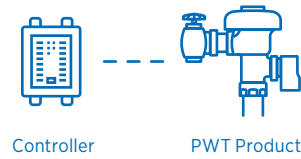
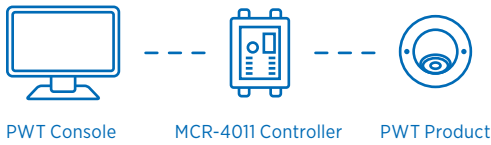

Communicating

In scenarios where the water usage and system must be monitored in real time, Sloan offers a management console solution. The PC-based software solution operates without a connection to the Internet, making it ideal for prisons and facilities where internet access is limited for security purposes. Control settings, reports, and alerts are provided.

Products

- PWT Management Console
- MCR-4011 controller
- Buttons for lav hot and cold water, shower, and flush valve
- Electronic series (ES) flushometer
- Manifold (optional)
- Shower solenoids and heads

Controller Connections

- MCR-4011 controller to PWT Management Console
- Buttons to MCR-4011 inputs
- Flushometer, lavatory, and shower solenoid to MCR-4011 outputs
- 24V power supply

Non-communicating

PWT systems control water usage across fixtures by limiting the number and length of activations. Should a user attempt to flush a toilet more than the allowed number of times, the system will prevent the toilet from flushing again for up to 4.5 hours in 15 minute increments (lockout time). Faucet run times may be set in seconds, and shower lengths can be limited to a few minutes. This prevents unnecessary water usage and minimizes the chance of misuse or abuse. At the heart of the control are the MCR-4014 and MCR-8012 controllers.

Products

- MCR-4014 for one cell or four devices, or MCR-8012 controller for 8 devices or 2 cells
- Buttons for lavatory hot and cold water, shower, and flush valve
- Electronic series (ES) flushometer
- Manifold (optional)

Controller Connections

- Buttons to MCR-4014 or MCR-8012 inputs
- Flushometer, lavatory, and shower solenoid to MCR-4014 or MCR-8012 outputs
- 24V power supply

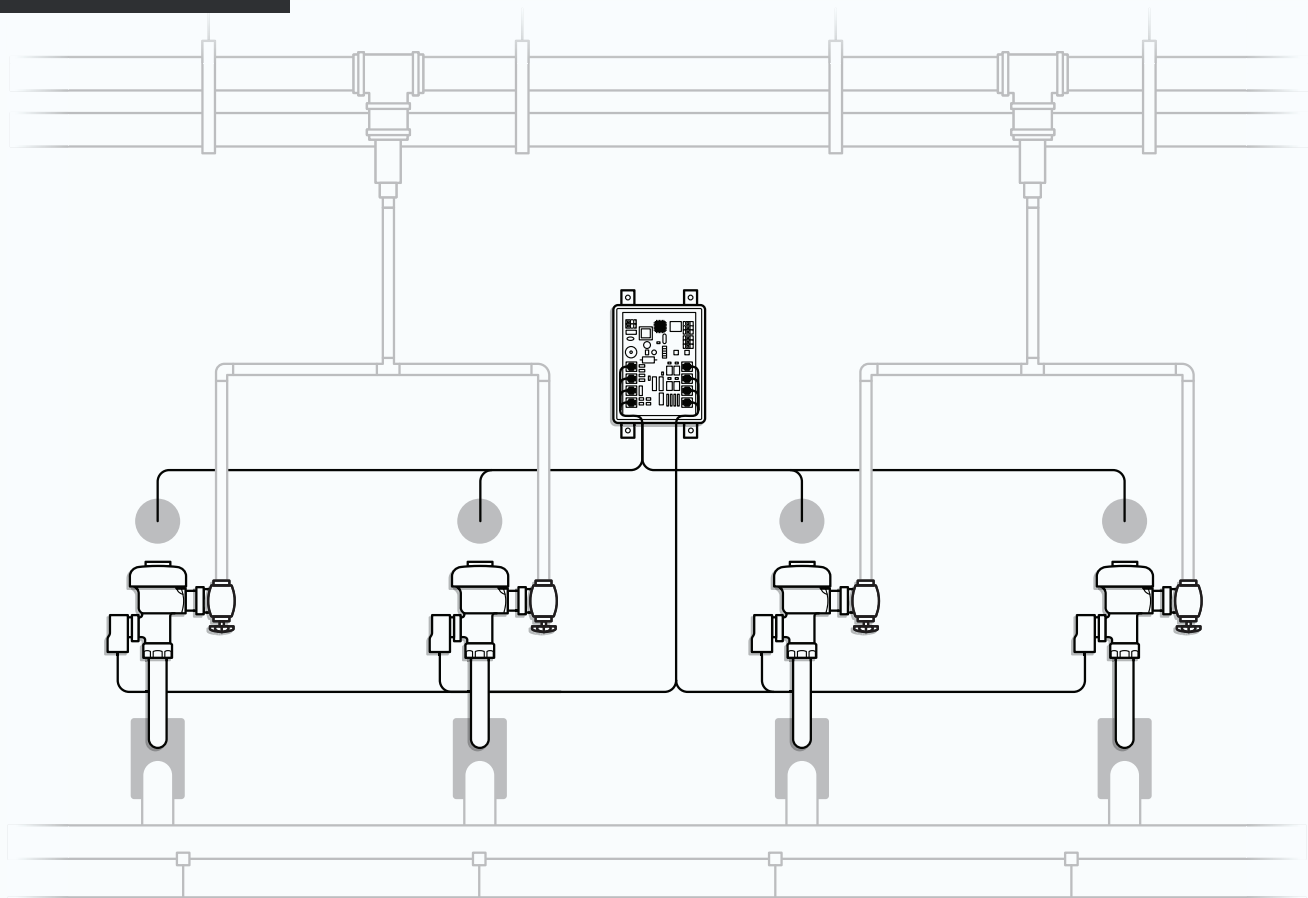

Toilets Line Diagram

Toilet Activation Control

Toilets use a significant amount of water and sewer resources. One flush can use as much as 3.5 gallons of water, so excess flushes quickly run up water usage. Equally concerning is the misuse of the toilets—for example in a prison—they are used to flush linens and clothing down the pipes and to get rid of contraband. Inmates can purposely clog a toilet, then repeatedly flush it causing the fixture to overflow. Once the water spills over, the inmate must be removed from the cell for cleaning resulting in “punishment” of extra time out of the cell.

By limiting the number of flushes, or activations, in a given amount of time, management can prevent or dramatically minimize this type of abuse. Should a user attempt to flush a toilet more than set number (typically 2 times in 5 minutes), the controller will initiate a lockout to prevent the toilet from flushing again for up to 60 minutes.

Products

- MCR-4014 or MCR-8012 controller with water closet control program
- Buttons—one for each flushometer
- Electronic series (ESM) flushometer

Connections

- Buttons to MCR-4014 or MCR-8012 inputs
- Flushometers to MCR-4014 or MCR-8012 outputs
- 24V power supply

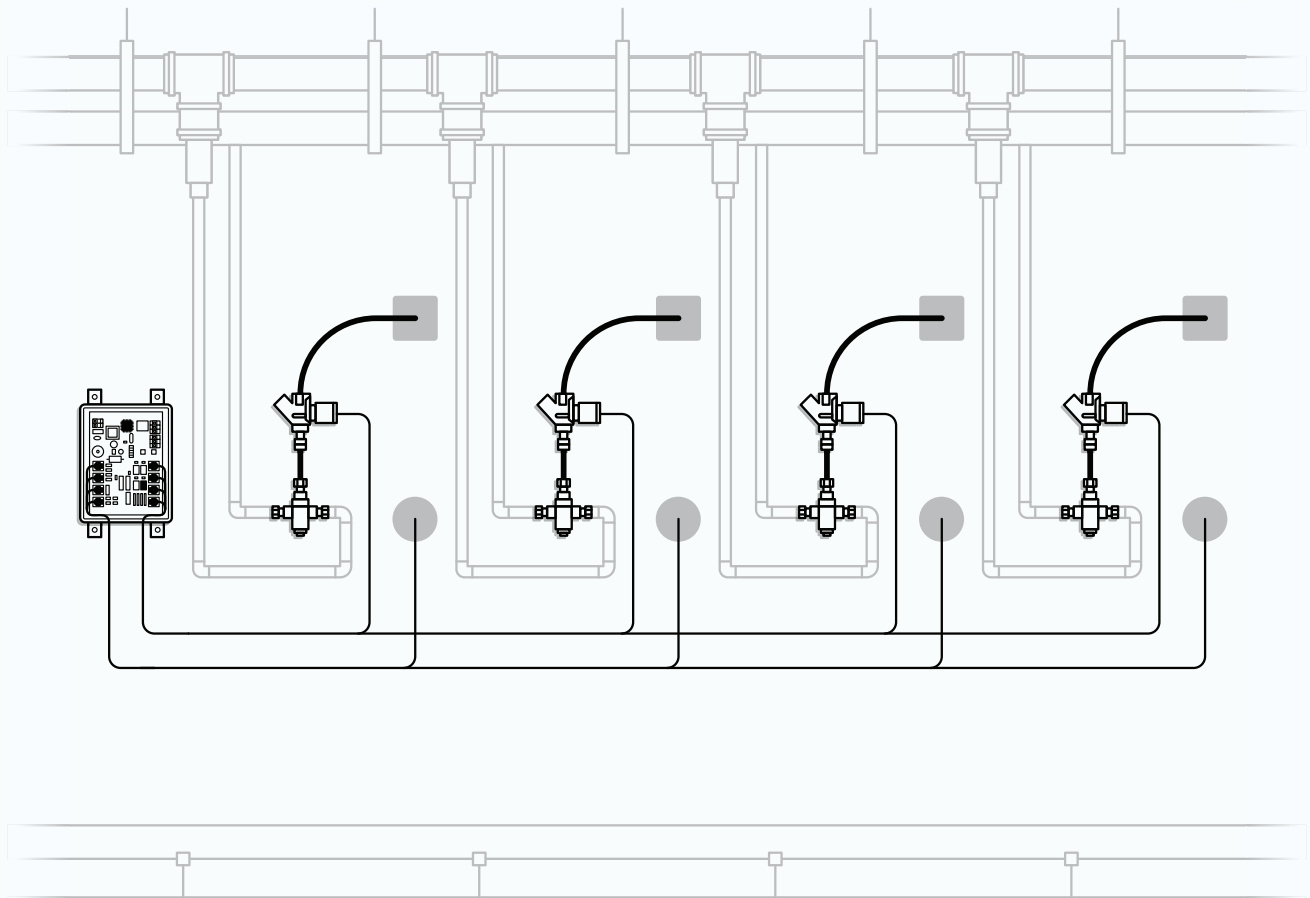

Showers Line Diagram

Shower Control

Patients and inmates are known to leave the shower water running. Cold water helps cool the room while hot water helps warm the area. Even if a button is used that causes the system to time out, it is not difficult to wedge an object over the button to force it to keep the water running. Besides excess water usage, this can cause a dangerously wet floor.

The PWT system allows management to control the length a shower can run to prevent misuse and abuse. This is done by selecting a “showers-only” program on the controller.

Products

- MCR-4014 or MCR-8012 controller with shower program option
- Buttons (such as the MCR-231) for each shower
- MCR-139-A shower solenoid or manifold
- Thermostatic mixing valve

Connections

- Buttons to MCR-4014 or MCR-8012 inputs
- Shower to MCR-4014 or MCR-8012 outputs
- 24V power supply



Flushometers

Sloan offers several specialty PWT flushometers designed to withstand harsh environments such as prisons, park districts, and mental health facilities. They feature all the performance benefits of standard concealed, diaphragm, and piston model flushometers with the added durability you expect from Sloan. The portfolio includes hydraulic, and controller compatible models to limit the number of flushes in a given time, and battery-powered versions for areas where water control is needed but power is unavailable.

Water closet flush volume options include 1.28, 1.6, 2.4, and 3.5 gpf (gallons per flush). All flushometers meet BAA.

When selecting the optimal flushometer for your needs, be certain to add the following:

- Button so toilet can be flushed in the cell/room
- 24V power supply
- Flush control requires MCR-4014 or MCR-8012 controller and ESM series flushometers

PWT Flushometer Series

Sloan offers a variety of concealed flushometer solutions for toilet control.

1. For basic toilet activations, Sloan offers the Regal® 603 and Royal® 603 families of manual flushometers. They operate through the use of a button located in the cell or room. If hydraulic flushometers are desired, the Royal 9603, Regal 9603 and Crown® 9603 series are ideal.
2. When control measures are required to minimize water abuse and vandalism risk, Sloan provides a series of electronic flushometers, identifiable by the 'ESM' (Electronic Solenoid Modular Plug) nomenclature in their model name. The hardwired flushometers are connected to a four-port or eight-port controller. The controller then limits the number of activations (flushes) in a given time period with lockout options that prevent the toilet from flushing again for up to 60 minutes. A button in the room or cell is used for activations. Standard lockout times are 15, 30, 45, and 60 minutes.
3. When the chase configuration makes it difficult to install power or connect controllers Sloan's 8603-ESM family of flushometers are ideal. The control programs are built into the valve head so control is provided by the stand-alone flush valve. There are battery operated versions for environments where power isn't available as well as hardwired versions. RESS kits are available to upgrades to existing facilities. The 8603-ESM flushometer series operates with a touch button in the cell. Standard and LED touch buttons are offered.
4. When selecting the optimal flushometer for your needs, be certain to add the following:
 - Button for toilet flush
 - 24V power supply
 - Flush control require MCR-4014 or MCR-8012 controller and ESM series flushometer or an 8603-ESM flushometer



Sloan® 8603-ESM Battery-powered Flushometer

Manual

Sloan's durable prison flushometers are known for their quality and ability to operate in harsh environment. The concealed flushometers are for use in any setting. They provide manual flushes and are activated through a push button in the cell or room.

- Royal® 601 and 603 concealed manual specialty prison valve series

Hydraulic

For projects requiring a hydraulic flush valve, Sloan's 9603 concealed specialty flushometers are ideal. They provide manual flushes and are activated through a push button in the cell or room. Hydraulic valves are used with specialty buttons such as the HY-108-A ADA compliant push button.

Concealed manual specialty water closet hydraulic flushometers:

- **Royal 9603**
- **Regal® 9603**
- **Crown® 9603**
- **Sloan® 9603**

Electronic

Sloan's electronic concealed specialty flushometers are diaphragm model flushometers with added durability to withstand rough environments. The hardwired valves may be connected to a Sloan MCR four port or eight port controller for activation limits and lockout times so water usage may be managed throughout the facility.

Concealed solenoid (less sensor) hardwired water closet flushometers:

- **Crown 603-ES**
- **Regal 603-ES, 609-ES, 611-ES, 150-ES Series**
- **Royal 603-ES Series**
- **Sloan 650-ES**



Royal 601 and 603 concealed manual specialty prison valves



Royal 9603 line, concealed manual specialty water closet hydraulic flushometer



Royal 603-ES

Electronic with integrated programming

Sloan® 8603-ESM Flushometers feature all the performance benefits of standard concealed, diaphragm model flush valves with added durability to withstand rough environments. The 8603-ESM series is designed for independent operation in environments where a controller is not cost efficient. Its vandal-proof, touch-button operation is designed with a non-hold-open feature to keep the fixture from surpassing intended water consumption.

Each model has integrated firmware that provides 5 programs designed to minimize water usage and misuse. The programs provide 2 activations in 5 minutes with lockout options of 15, 30, 45, and 60 minutes plus a dorm option. The dorm option allows a toilet to be flushed once per minute and is designed for dormitory style common use restrooms. The programs are field changeable to meet the requirements of most applications.

8603-ESM series flushometers include a touch button for operation. Both a standard (MCR-325) and an ADA compliant LED version (MCR-324L) are available.

- **8603-ESM** Battery-powered, built-in control providing 2 flushes in 5 minutes, 5 lockout time options. Other programs available which provide 3 flushes in 15 minutes and 3 flushes in 5 minutes.
- **8603-ESM-HW** Built-in control providing 2 flushes in 5 minutes, 5 lockout time options, hardwired with battery backup.
- **PWT-ESM RESS Kit Battery-powered** Battery-powered RESS kit with built-in control providing 2 flushes in 5 minutes, 5 lockout time options.
- **PWT-ESM-HW RESS Kit** Hardwired with battery backup RESS kit with built-in control providing 2 flushes in 5 minutes, 5 lockout time options.



Sloan 8603-ESM battery-powered flushometer



PWT-ESM-HW RESS kit

PWT Buttons

Sloan provides waterproof, rugged button assemblies to activate flushometers, showers, and lavatories in prisons, mental health institutions, and other high abuse environments.

Activation Button Assemblies

- **HY-108-A** ADA compliant hydraulic push button for use with Sloan 9600 series hydraulic flushometers.
- **MCR-140** Waterproof push button for use with any PWT controller. Activates water closets, lavatories, and showers.
- **MCR-183** Waterproof push button for use with any PWT controller. Mounts on fixture back splashes, wall box covers, or walls up to 2.5" thick. Activates water closets, lavatories, and showers.
- **MCR-184** Waterproof, thru-wall push button for use with any PWT controller. Activates water closets, lavatories, and showers. Up to 13" wall thickness.
- **MCR-60** Thru-wall button for use with any PWT controller. Activates water closets, lavatories, and showers.
- **MCR-231** Waterproof piezo button for use with any PWT controller. Used on fixtures with "D" shaped hole. May be used to activate flushometer, lavatory, and shower solenoids.
- **MCR-324-L** Touch button with LED indicator for lockout condition. Ideal for ADA installations. Use with 8603-ESM series flushometers.
- **MCR-325** Touch button for use with 8603-ESM series flushometers. Removable flange. Includes universal mounting kit, up to 10" wall thickness. Can also be mounted to fixture back splash.
- **MCR-326-RJ11** MCR-326 touch button with removable flange. Includes universal mounting kit, up to 10" wall thickness. Used with MCR-4011, MCR-4014, and MCR-8012 series controllers.
- **MCR-326L-RJ11** MCR-326L touch button with LED lockout indicator. Used with MCR-4011 series controllers.



MCR-140 activation button assembly



MCR-231 activation button assembly



MCR-324-L activation button assembly

PWT Manifolds

PWT manifolds are used to supply hot, cold, and mixed water to lavatory and shower fixtures. Sloan offers two series: the copper MCR-100 series and the MCR-321 series. They are used in conjunction with PWT control modules to provide accurate control of lavatory or shower run times, and they support a 160 degrees F maximum water temperature.

The MCR-100 series use electronically-activated solenoids to supply water to lavatory fixtures. Copper manifolds are ideal for areas with hard water. The MCR-321 series are compact mixing manifolds with a small footprint. Each is a complete mounting system that includes back-check valves and hoses. The easy-to-install series provides 0.5 gpm water flow, and a 2.5 gpm option is available for the one line manifold.

Copper Mixing Manifold Models

- **MCR-101** Single line
- **MCR-102** 2 line
- **MCR-104** 4 line

Compact Mixing Manifold Models

- **MCR-321A-1** ASM single line 0.5 gpm
- **MCR-321A-1-2.5** ASM single line 2.5 gpm
- **MCR-321A-2** ASM single line 0.5 gpm
- **MCR-321A-4** ASM single line 0.5 gpm

Manifold Connections

- Water lines: hot/cold in. Mixed water output to shower or lavatory.

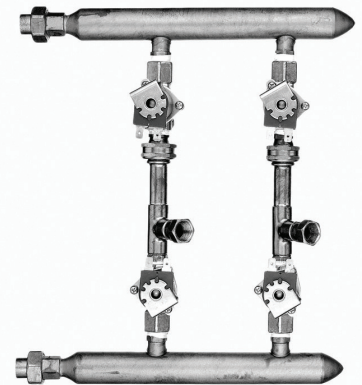

MCR-102 PWT system 2 line mixing manifold

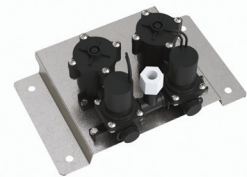

MCR-321A-1 manifold ASM 1-line mix 0.5 gpm

PWT Controllers

Controllers

Sloan PWT control modules are field-programmable and may be configured to control lavatories, water closets, showers, or combination fixtures. The control modules have an IP53 rated enclosure with a hinged door for use in tough environments. There are two categories of control modules: non-communicating and communicating.

The MCR-4004/MCR-4014 and the MCR-8002/MCR-8012 control modules are non-communicating controllers which provide four and eight ports respectively.

The MCR-4001/MCR-4011 families are four port communicating controllers designed for use in conjunction with the PWT Management System Console. They can be programmed for delays, scheduled runtimes, or complete lockouts to prohibit improper usage of water closets, lavatories, and showers.

PWT control modules are used with PWT push buttons, electronic flushometers, and solenoids to control water closets, lavatories, and showers. They utilize 24VAC-50/60Hz operating voltage which is supplied by a Sloan transformer such as the EL-154.

Non-communicating Models

- **MCR-4004/MCR-4014** 4 port non-communicating for control of 1 restroom or cell, 4 toilets, or 4 showers
- **MCR-8002/MCR-8012** 8 port non-communicating for control of 2 restrooms or cells, 8 toilets, or 8 showers

Communicating Models

- **MCR-4001/MCR-4011** 4 port communicating for use with PWT Management Console for monitoring and control of 1 restroom or cell, or 4 toilets

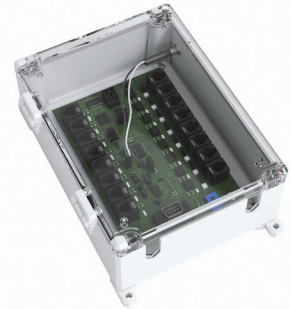

MCR-8012 PWT controller

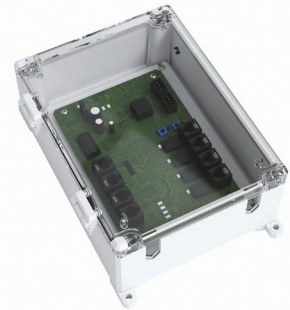

MCR-4011 PWT controller

Controller Programs

Sloan offers several pre-programmed PWT controllers to manage water use in different applications. Custom programs can be developed if a scenario requires control of a unique combination of PWT products.

MCR-4011 Programs

-AL-001	Showers only. Dual activation times. 1 and 2 minute shower run times.
-AL-002	Water closets only. Random 60 second delays before and after flush. 1 hour lockout.
-AL-004	Water closet, lavatory, and shower combination. 20 second hot lavatory run time, 10 second cold lavatory run time, 1 hour water closet lockout, and 1 and 2 minute shower cycle.
-AL-005	Showers only. 3 minute run time with 20 second lockout after shut off.

MCR-4014 Programs

-A	Provides control of lavatories, showers, water closets, or combination fixtures. Field programmable to control other product combinations.
-CA	Field-programmable to control all water closets or combination fixtures.

MCR-8012 Programs

-001	Pre-tempered showers with adjustable runtime. Factory set for 3 minute runtime.
-003	Hot/cold lavatory and water closets. Adjustable lock-out time on water closets. Factory set for 1-hour lock-out time.
-004	Water closets with adjustable lock-out time. Factory set for 1 hour lock-out time.
-005	Combination fixture controls up to two sets of a hot/cold water lavatory, a flushometer, and a shower. Adjustable default run time and lock-out times. Factory set for 1 hour lock-out time.

Controller Connections

- Buttons to controller inputs
- Products to controller outputs
- 24VAC power source or transformer
- Optional communication system: FT-10 twisted pair from MCR-4001/MCR-4011 to PWT management console

PWT Shower Products

Sloan provides the products necessary to control the length and temperature of a shower. They can be installed in prisons, water parks, gyms, and health institutions. The portfolio includes complete kits with shower controllers, heads, and kits that include a shower head, control module, sensor module, solenoid, RJ-11 connections, and power cord.

Shower Heads

PWT institutional shower heads are wall-mounted self-cleaning shower heads with adjustable spray direction and integral flow control. 1.8 gpm, 2.0 gpm, and 2.5 gpm are supported. The shower heads are in conformance to all requirements of ANSI/ASME standard A112.18.1M, CSA B-125, and the United States Federal Energy Policy Act.

Models

- **AC-450** Act-O-Matic institutional showerhead
- **AC-460** Act-O-Matic institutional behind-the-wall installation showerhead
- **AC-11** Act-O-Matic standard with thumb screw volume control showerhead
- **AC-51** Act-O-Matic standard showerhead

Shower Head Connections

- Button to activate shower
- Shower solenoid such as the MCR-139A or manifold
- Optional MCR-4014/MCR-8012 or MCR-4011 controller to manage activation times and lockouts



AC-450 Act-O-Matic® institutional showerhead



AC-11 Act-O-Matic standard showerhead

Shower Sensor Controller

The PWT infrared shower sensor controller offers electronic shower control. The NEMA 6 compliant sensor module is used with the PWT infrared sensor and solenoid to control a single shower. Water run times and sensor ranges are adjustable.

Model

- **ETF-492** Infrared shower sensor controller

Shower Sensor Controller Connections

- Infrared sensor
- Solenoid
- Extension cord kit for installations up to 35' from sensor

Shower System Kits

Sloan provides several shower system kits that consist of components needed to install a shower system. Single wire extension cords are available that range from 6' to 50' in lengths for applications with longer distances between the control module and sensor.

Below is a sample of the kits Sloan provides for shower systems.

- **MCR-176** Infrared system includes five components: ETF-492-A infrared shower sensor controller, EL-154 24VAC transformer, MCR-139-A shower solenoid, ETF-458-A power cord kit, and ETF-462-A wall mount shower sensor.
- **MCR-216** Infrared system with shower head. Includes ETF-492-A infrared shower sensor controller, EL-154 24VAC transformer, MCR-139-A shower solenoid, ETF-458-A power cord kit, ETF-462-A wall mount shower sensor, and AC-450 shower head.
- **MCR-223** Push button shower system for a single pre-mixed shower. Includes MCR-115A single shower control, EL-154 24VAC transformer, MCR-139-A shower solenoid, ETF-458-A power cord kit, and AC-11 shower head.
- **MCR-224** Push button shower system for a single pre-mixed shower. Includes MCR-115-A single shower control, EL-154 24VAC transformer, MCR-139-A shower solenoid, ETF-458-A power cord kit, and AC-450 shower head.



MCR-216 infrared system includes ETF-492-A, EL-154, MCR-139-A, ETF458-A, EL462-A, and AC-450 shower head

PWT Management System

Sloan's PWT Management Console provides access to the status and usage patterns of the fixtures in its network and the data to keep them running. It allows users to review water usage information and product status in real-time. Water use may be controlled through setting shower length and limiting the number of toilet activations in a given time.

The solution provides a series of alerts and reports on water usage. Water usage may be tracked over time, providing the insights required to adjust settings as needed.

Key Software Features

- User settings and management
- Facility, area, floor, and room layout views
- Fixture images for toilet, sink, combi, and shower with color indication of fixture status
- Remote device/fixture activation, enable, and disable capabilities
- Alerts and alert logs
- Reports
- Help screens

Each system contains either a laptop or a desktop PC with a monitor and an MCR-282 USB port connector for MCR-4011 connections. A touch monitor is optionally available for the desktop model. The system operates on Windows 10 and includes required Windows licenses. Options include a graphical user interface.

Models

- **MGT SYS PC** Standard monitor, MCR-282 USB port connector
- **MGT SYS PC-T** Touch monitor, MCR-282 USB port connector
- **MGT SYS PC-TG** Touch monitor, graphics, MCR-282 USB port connector
- **MGT SYS LAP-T** Laptop, touch screen, MCR-282 USB port connector
- **MGT SYS LAP-TG** Laptop, touch screen, graphics, MCR-282 USB port connector

Connections

- **MCR-282** USB port connector to MCR-4011 controllers



MGT SYS PC-TG, touch monitor, graphics, MCR-282 USB port connector



MGT SYS LAP-T, touch screen, MCR-282 USB port connector

Accessories

Sloan provides many accessories and items to complete your PWT and configurations. Solenoids, 24V power transformers, spare parts, and cable extenders are all available for your installation.

PWT Solenoids

Solenoids are commonly used in shower systems. One of the more popular models for shower systems is the MCR-139-A.

- **MCR-139-A** PWT system solenoid
- **MCR-194** PWT system lavatory/shower system retrofit kit
- **MCR-208** PWT system solenoid kit, 24VAC, retrofit solenoid kit

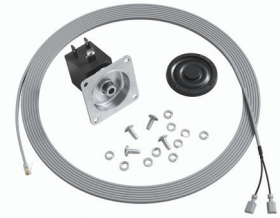

MCR-194 PWT system lavatory/shower system retrofit kit

PWT Transformers

PWT transformers are used to operate multi-combinations of fixtures. The majority provide 24VAC output. Some of the more popular transformers for PWT are listed below.

- **EL-154** Box-mount 120VAC input/24VAC output, 50/60Hz, 50VA. Will power up to 10 Optima® ES-S water closet or urinal flushometers
- **EL-208** PWT system 100VA transformer
- **MCR-426** PWT system 24VAC/50VA plug-in transformer. Class 2 transformer.
- **MCR-427** 24V/100VA plug in transformer, Class 2 step-down

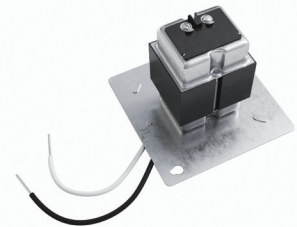

EL-154 box mount 120VAC input/24VAC output, 50/60Hz, 50VA

PWT-8IO-PROG-USB

PWT-8IO programmer for MCR-8002 and MCR-8012.

The USB based program allows a user to program their MCR-8001 and MCR-8012 controllers through a laptop or desktop PC. Once it is loaded onto a PC, users may connect to a PWT 8 I/O controller with the included USB to RS232 adapter cable.



Front cover: ST-2469 Vitreous China Wall-mounted Water Closet and SU-1009 Vitreous China Washdown Urinal with MCR-325 Touch Button.
Back cover: AC-450 Act-O-Matic® Institutional Showerhead with MCR-325 Touch Button.

SLOAN®
Water Connects Us®

World Headquarters

10500 Seymour Avenue
Franklin Park, IL 60131
U.S.A.

800.982.5839
sloan.com

Follow Sloan

[f /sloanvalvecompany](https://www.facebook.com/sloanvalvecompany)

[@sloan_valve](https://twitter.com/sloan_valve)

[@sloan_valve](https://www.instagram.com/sloan_valve)

[/sloan_valve](https://www.pinterest.com/sloan_valve)

[in /sloan-valve-company](https://www.linkedin.com/company/sloan-valve-company)